

Name Hertz, Heinrich
last first

Student ID 299,792,458

I. Lecture multiple choice (43 pts.) ANSWER ON SCANTRON SHEET.

For questions 1-3, four resistors are connected to an ideal battery as shown. After the switch is closed, the system quickly reaches a steady-state condition so that all currents are constant. Use the following values:

$R_1 = 10\Omega, R_2 = 20\Omega, R_3 = 30\Omega, R_4 = 60\Omega$

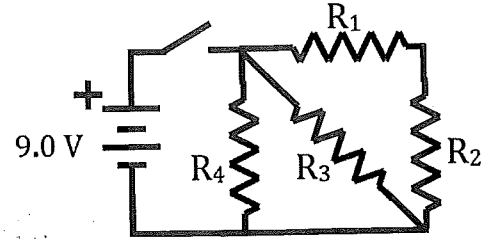

1. (3 pts) Which choice best represents the equilibrium potential difference across R_2 ?

- A. 3.0 V
- B. 4.5 V
- C. 6.0 V
- D. 7.5 V
- E. 9.0 V

$$9V \frac{20}{20 + 10} = 9V \frac{2}{3} = 6V$$

2. (3 pts) What is the ratio between current flowing through resistor R_4 and R_3 ?
 Current through R_4 / Current through R_3 is given by:

- A. 1
- B. 2
- C. 0.5
- D. 0.25
- E. 4

$$\frac{I_4}{I_3} = \frac{V}{R_4} \frac{R_3}{V} = \frac{R_3}{R_4} = \frac{30}{60}$$

3. (3 pts) Which choice best represents the equivalent resistance of the four resistors?

- A. 100 Ω
- B. 0.092 Ω
- C. 47 Ω
- D. 77 Ω
- E. 12 Ω

$$\frac{1}{\cancel{R_1} + R_2} + \frac{1}{30\Omega} + \frac{1}{60\Omega} = \frac{1}{R_{eq}}$$

$$\frac{1}{30\Omega} + \frac{1}{60\Omega} = \frac{2}{60\Omega} + \frac{1}{60\Omega} = \frac{3}{60\Omega} = \frac{1}{20\Omega}$$

$$\frac{1}{20\Omega} + \frac{1}{60\Omega} = \frac{3}{60\Omega} + \frac{1}{60\Omega} = \frac{4}{60\Omega} = \frac{1}{15\Omega}$$

$$\frac{1}{15\Omega} = \frac{4}{60\Omega} \Rightarrow R_{eq} = \frac{60\Omega}{4} = 15\Omega$$

Questions are related. A circuit schematic is shown to the right. Before $t = 0$, the switch S is in the open positions. For $t > 0$ the switch is in the closed position.

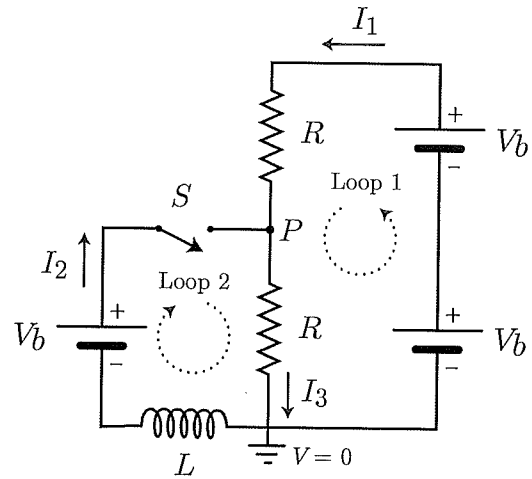

4. (3 pts) Apply charge conservation (**Kirchhoff Current Law**) after S is closed. What is the relation between the three currents?

A. $I_1 + I_2 + I_3 = 0$

B. $I_1 = I_3$

C. $I_1 + I_2 = I_3$ $I_{in} = I_{out}.$

D. $I_2 = I_3$

E. $I_1 = I_2$

5. (3 pts) Which equation applies the **Kirchhoff Voltage Law** to loop 2 for $t > 0$?

A. $0 = I_3 R + L I_2 + V_b$

B. $0 = I_2 R - L dI_2/dt + V_b$

C. $0 = I_3 R + L dI_3/dt + V_b$

D. $0 = I_3 R + L dI_2/dt - V_b$

E. $0 = I_2 R - L dI_2/dt - V_b$

6. (2 pts) For $t < 0$, **what is the voltage** at point P ?

A. $V = 0.$

B. $V = 2V_b.$

C. $V = V_b.$

D. $V = I_2/R.$

E. $V = -I_3/R.$

7. (3 pts) Just after the switch S is closed, **what is the current** I_2 ?

A. $I_2 = V_b/R.$

B. $I_2 = -V_b/R.$

C. $I_2 = V_b/2R.$

D. $I_2 = 0.$

E. $I_2 = -V_b/2R.$

8. (2 pts) In the large t limit, **what is the current** I_2 ?

A. $I_2 = V_b/R.$

B. $I_2 = -V_b/R.$

C. $I_2 = V_b/2R.$

D. $I_2 = 0.$

E. $I_2 = -V_b/2R.$

For questions 9-11, a thin conducting rod of length $\ell = 20$ cm is sliding to the right with a constant speed of 10 m/s along conducting rails that are connected by a resistor $R = 2.0$ Ohm. The whole system lies inside a uniform magnetic field \mathbf{B} which is directed into the page and has a magnitude of 0.80 Tesla. The resistance of the rod and the rails are negligible.

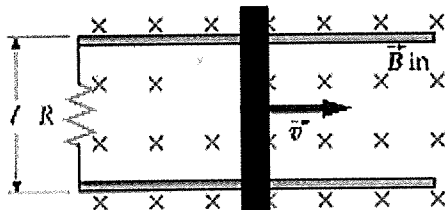

9. (3 pts) What is the induced emf in this circuit?
- A. 0.80 V
 - B. 1.2 V
 - C. 1.6 V
 - D. 2.0 V
 - E. 4.0 V

$$\mathcal{E} = v B L$$

\swarrow \searrow \nwarrow \nearrow
 10 m/s 0.8 T 0.2 m

10. (3 pts) What is the induced current in this circuit?
- A. 0.80 A clockwise
 - B. 0.80 A counterclockwise
 - C. 1.6 A clockwise
 - D. 1.6 A counterclockwise
 - E. 4.0 A counterclockwise

$$R = 2 \Omega$$

$$I = \mathcal{E} / R = 0.8 \text{ A}$$

11. (3 pts) What is the force exerted by the (external) magnetic field on the rod?
- A. 0.032 N to the left
 - B. 0.064 N to the right
 - C. 0.064 N to the left
 - D. 0.128 N to the right
 - E. 0.128 N to the left

$$F = I L B = (0.8 \text{ A})(0.2 \text{ m})(0.8 \text{ T})$$

12. (3 pts) The current in a wire along the x axis flows in the positive x direction, as shown. If a proton, located as shown in the figure, has an initial velocity in the positive z direction, it experiences

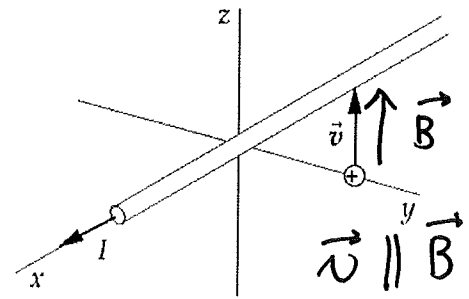

- A. a force in the direction of positive x.
- B. a force in the direction of negative x.
- C. a force in the direction of positive z.
- D. a force in the direction of positive y.
- E. no force.

13. (3 pts) Which of the following is a correct **integral for the B field** vector distance z from a loop carrying current I?

- A. $\vec{B} = \frac{\mu_0 I}{4\pi} \int_0^{2\pi} d\theta \frac{\hat{z} R^2}{(R^2+z^2)^{3/2}}$ ← wrong units
- B. $\vec{B} = \frac{\mu_0 I}{4\pi} \int_0^{2\pi} d\theta \frac{\hat{r} R}{(R^2+z^2)^{3/2}}$
- C. $\vec{B} = \frac{\mu_0 I}{4\pi} \int_0^{2\pi} d\theta \frac{\hat{z} R^2}{(R^2+z^2)^{3/2}}$
- D. $\vec{B} = \frac{\mu_0 I}{4\pi} \int_0^{2\pi} d\theta \frac{\hat{r} R^2}{(R^2+z^2)^{3/2}}$ ← wrong units
- E. $\vec{B} = \frac{\mu_0 I}{4\pi} \int_0^{2\pi} d\theta \frac{\hat{z} R^2}{(R^2+z^2)^3}$ ← wrong units

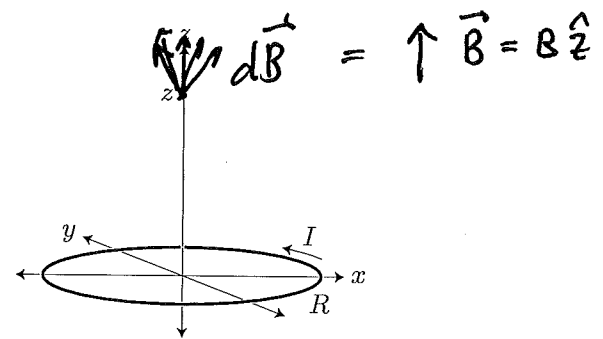

For problems 14 & 15, consider the Faraday Disk shown to the right. Assume the disk is conducting in the shaded regions and that it can rotate around the axel. The brushes allow current to flow from the wires into the disk but give rise to negligible friction when the disk is rotating. The circuit can either be powered by a battery (M) or measure induced current (G) depending on the position of the switch S. A represents an Amp meter.

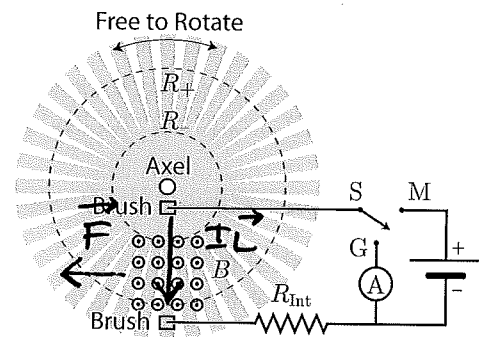

14. (3 pts) Switch S is connected to the M terminal. Current flows from the wire to the brush and through the disk. What happens when the switch is connected?

- A. No torque is generated
- B. The disk rotates in a clockwise direction.
- C. The disk rotates in a counter-clockwise direction.

15. (3 pts) Switch S is connected to the G terminal. The disk is then rotated in the clockwise direction with constant angular velocity. Any induced current is measured in the Amp meter A.

- A. No current is induced.
- B. An induced current flows in the clockwise direction.
- C. An induced current flows in the counter-clockwise direction.

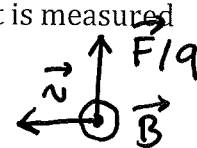

I. Lab questions [12 pts] ANSWER THESE ON YOUR SCANTRON SHEET.

16. [4 pts] Two identical light bulbs are connected in series with an ideal battery. Another light bulb of the same type is to be wired into the circuit, as indicated. Which connection below will **make bulb B dimmer** after the connection than before?

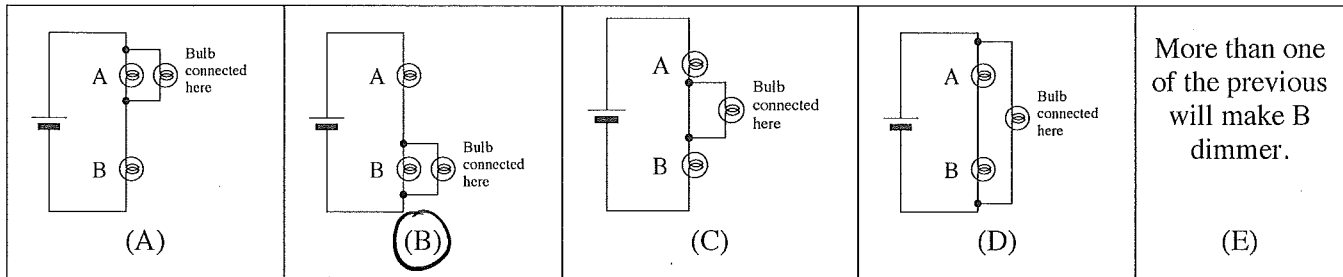

17. [4 pts] A voltage divider is constructed from identical 100 ohm resistors. For which version of the voltage divider is $V_{out} = \frac{1}{4}V_{in}$?

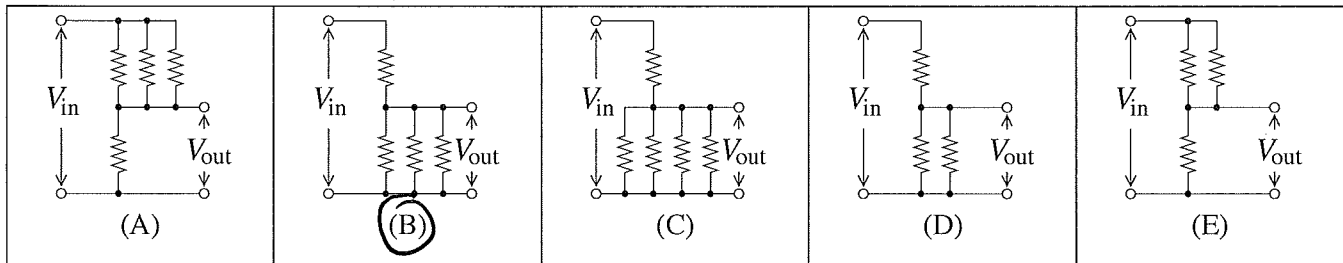

18. [4 pts] In an RC circuit, a switch is in position 1 for a long time. Then it is switched to position 2 and two observations are noted: (1) Bulb A is **initially much brighter** than bulb B, then (2) after a long time **both bulbs are glowing with the same brightness**. Which circuit below shows this behavior? Assume that the bulbs, capacitor and power supply are all as you used in the lab.

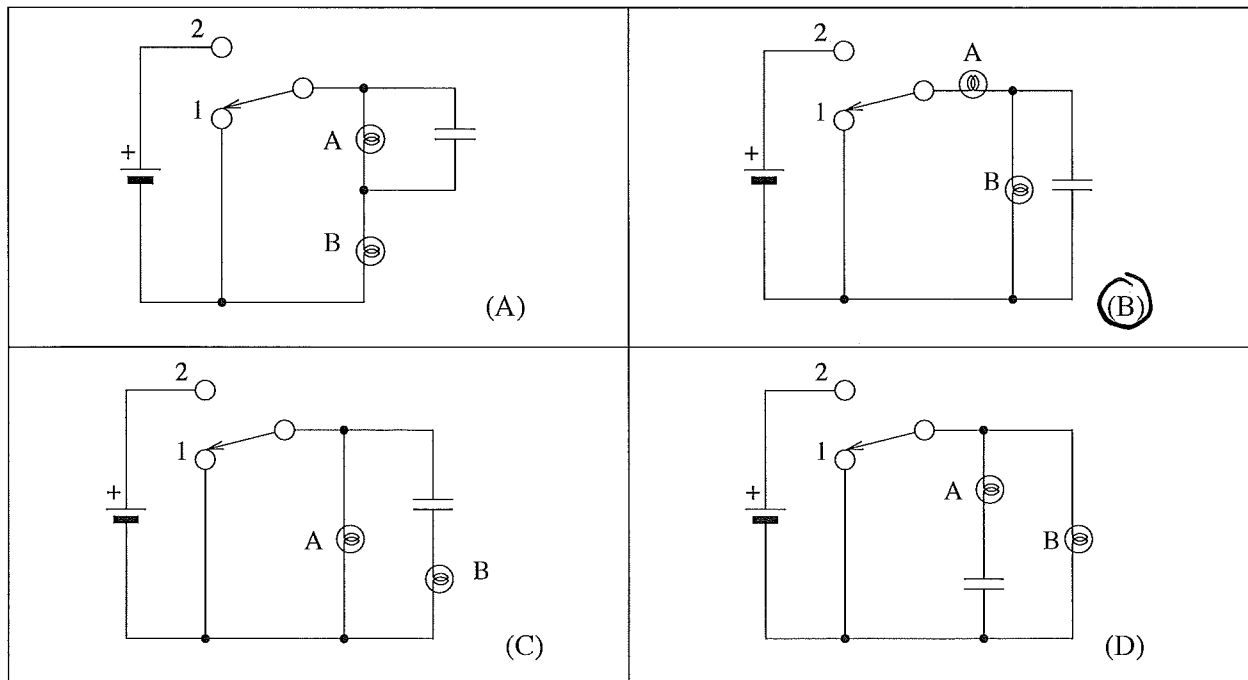

III. Lecture free response (25 pts). ANSWER ON EXAM.

The next two problems are related. An infinitely long solenoid is oriented along the z-axis as shown. The solenoid is wrapped with multiple concentric layers of wire with a density of n wires per unit cross-sectional area. The inner radius of the solenoid is r_1 and the outer radius is r_2 . The direction of the current I is shown in the figure to the right. (Note: B field is NOT shown.)

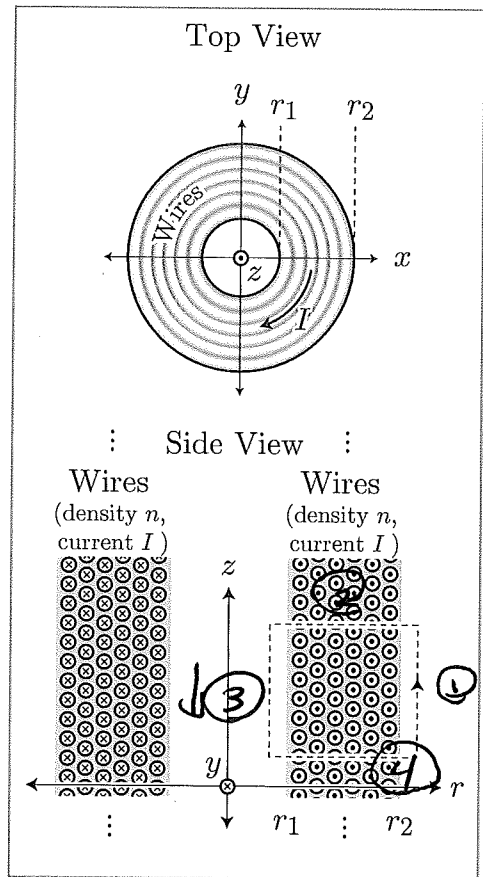

X. (3 pts) Sketch the B field vector at the seven points shown in the schematic below. Write "0" for any vectors that are zero magnitude. (Hint: The B field outside is zero.)

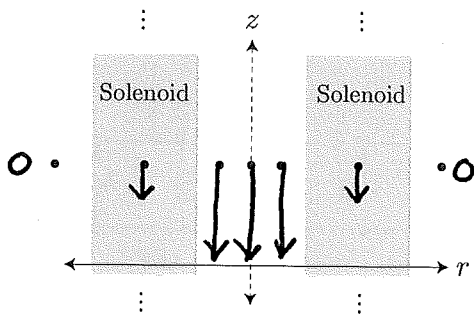

X. (8 pts) Use Ampère's Law to derive an expression for the B field vector as a function of r , r_1 , r_2 , n , I , and μ_0 . (Hint: Consider the Ampèrian Loop drawn in the side view.)

$$\oint \vec{dl} \cdot \vec{B} = \underbrace{BL}_{\textcircled{1}} + \underbrace{0}_{\textcircled{4}} + \underbrace{0}_{\textcircled{2}} + \underbrace{0 \cdot L}_{\textcircled{3}} = \mu_0 I n \Delta r = \mu_0 L \Delta r n I$$

$\vec{dl} \perp \vec{B}$

$$\Delta r = \begin{cases} r_2 - r_1, & r_1 < r < r_2 \\ r_2 - r, & r < r_1 \\ r_2 - r_2 = 0, & r > r_2 \end{cases}$$

Number of wires.

\vec{B} for $r < r_1$	$-\hat{z} \mu_0 I n (r_2 - r_1)$
\vec{B} for $r_1 < r < r_2$	$-\hat{z} \mu_0 I n (r_2 - r)$
\vec{B} for $r > r_2$	0

X. (5 pts) Sketch the z component of the B field in the figure to the right.

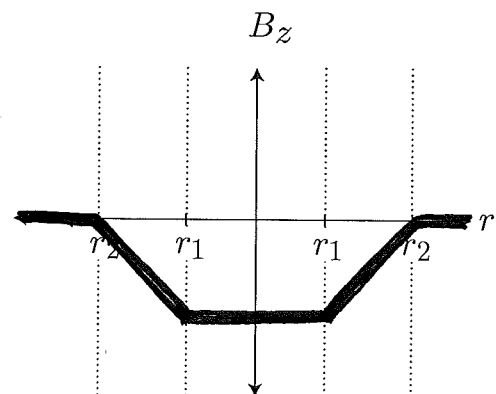

Name _____ Student ID Number _____
last first

The next three problems are related. Consider the RC circuit shown to the right. Before time zero, both switches are open and the capacitor is uncharged. At $t = 0$ switch S_1 is closed and the capacitor begins to charge. Switch S_1 is opened at $t = RC$. Then switch S_2 is closed at $t = 2RC$, discharging the capacitor.

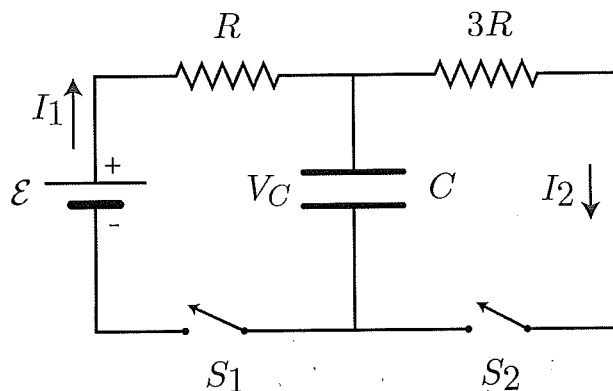

X. (3 pts) Sketch the plot of the voltage across the capacitor V_C .

X. (3 pts) Sketch the plot of the current I_1 . (Hint: NOT I_2 .)

X. (3 pts) Label max values and asymptotic values on both plots ($t \rightarrow \infty$).

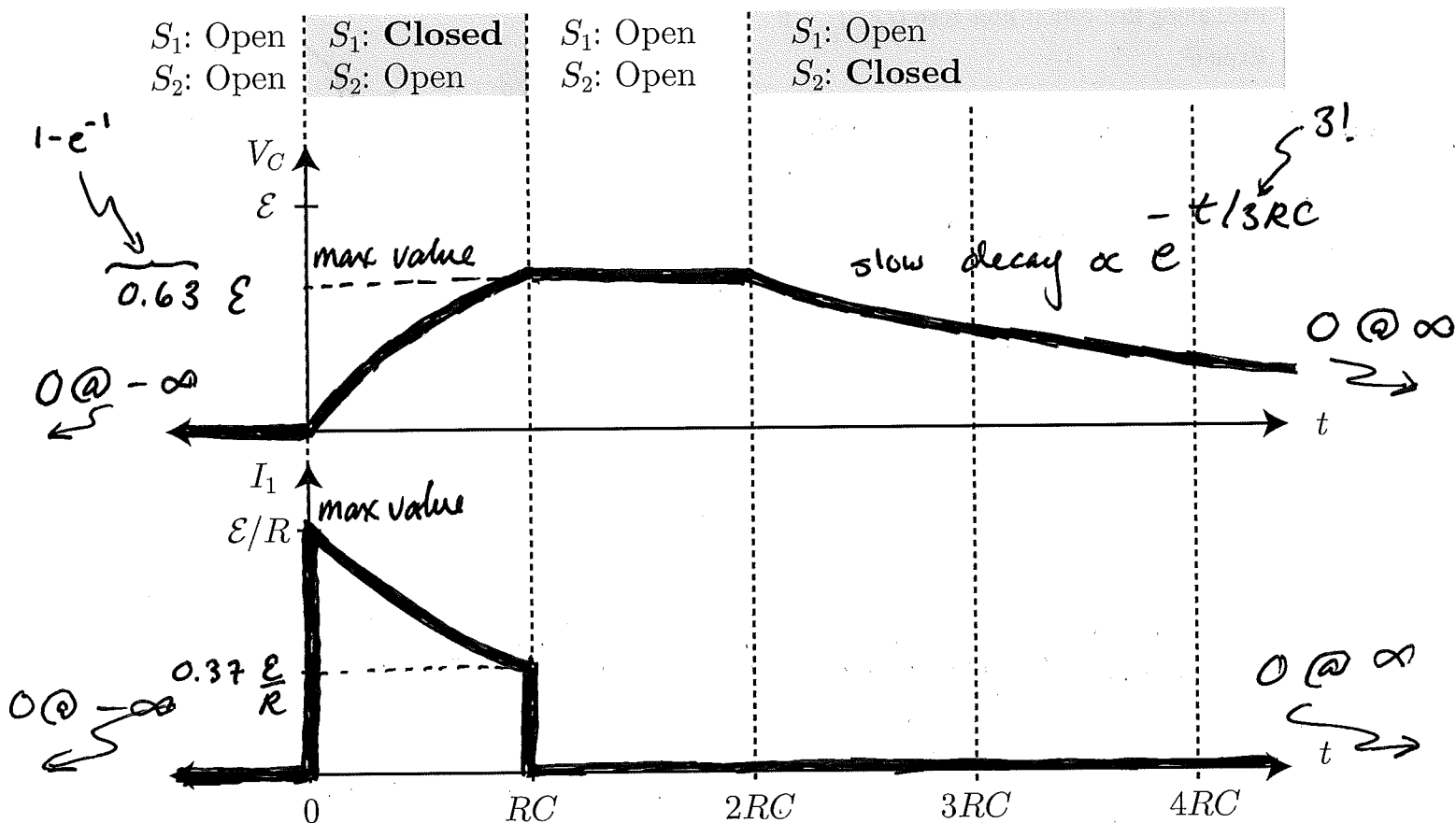

IV. [20 points total] Two very long wires each carry a current I_0 into the page. Magnetic field lines for the wires are shown at right. Three electrons near the wires, labeled A-C, all have a speed \vec{v}_0 to the left. Points A and B are each equidistant from the wires.

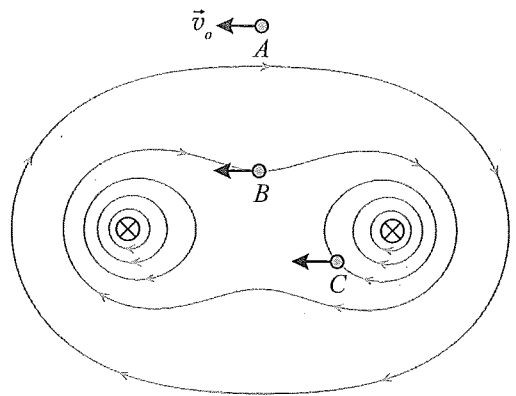

A. [7 pts] Rank the magnitude of the magnetic force on each electron. If the magnitudes at any two points are equal or zero, state so explicitly. Explain.

$$0 = F_A = F_B < F_C$$

$$\vec{F} = q \vec{v} \times \vec{B} \propto \sin \theta \Big|_{\theta=0} = 0. \quad \vec{v} + \vec{B} \text{ are } \parallel.$$

B. [7 pts] On the diagram at right, draw and label an **open path** for which the line integral of the magnetic field along that path is **non-zero** (i.e., $\int_{path} \vec{B} \cdot d\vec{l} \neq 0$). Explain.

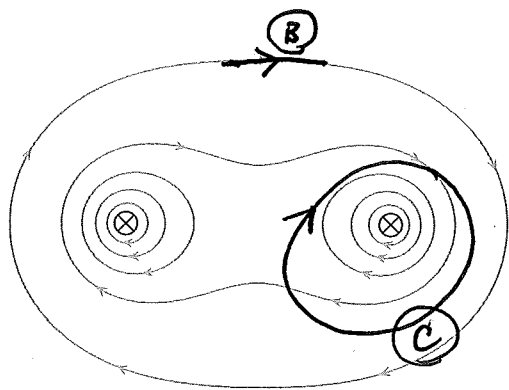

Draw any curve such that \vec{B} is not \perp to $d\vec{l}$.

C. [6 pts] On the diagram above, draw and label a **closed path** for which the line integral of the magnetic field along that path is **non-zero** (i.e., $\oint_{path} \vec{B} \cdot d\vec{l} \neq 0$). Explain your reasoning.

$$\oint d\vec{l} \cdot \vec{B} = \mu_0 I_{ins} \quad ; \quad \text{Ampère Law.}$$

$\neq 0$ for the curve drawn.